

GUK-O 2/1-70

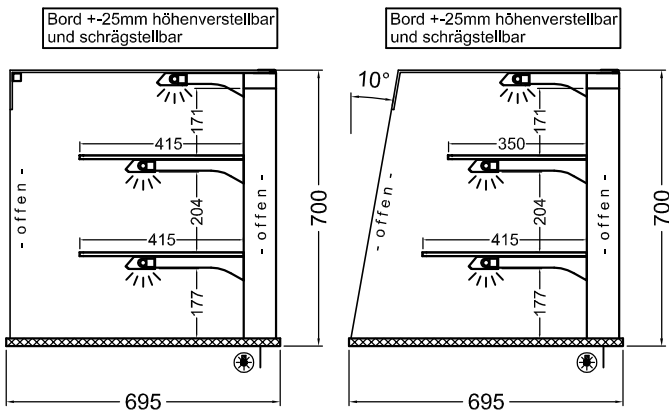

Variante GE

Variante GS